

1. BBV/NBV-B-RLT Einzel U11-U22 2010_OT - JE U17

1. Rövekamp, Hagen

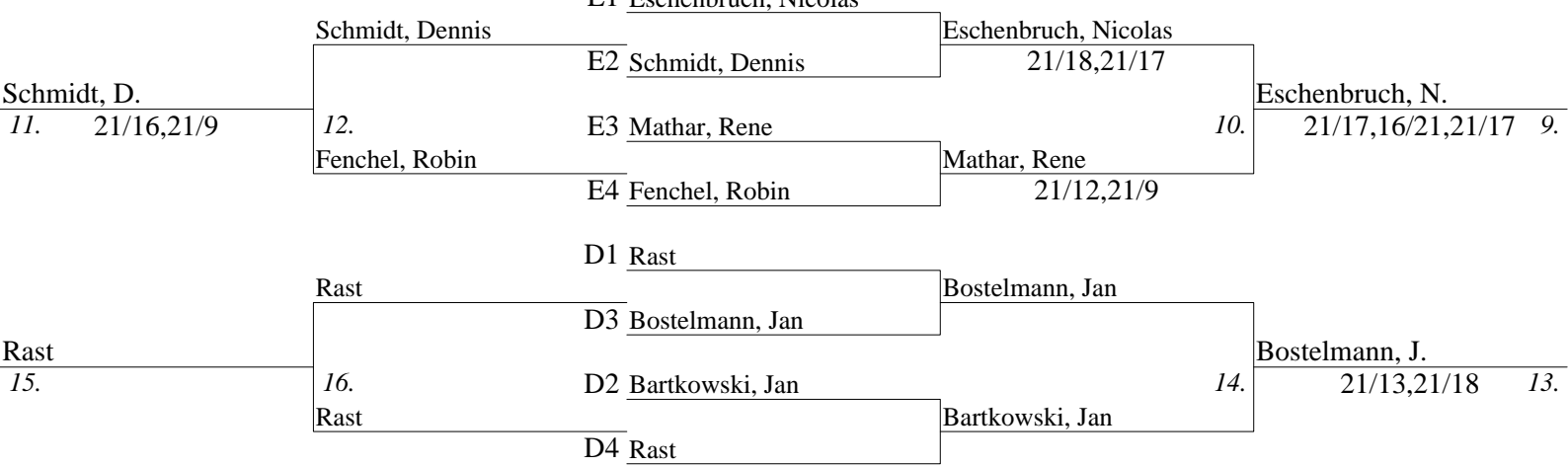
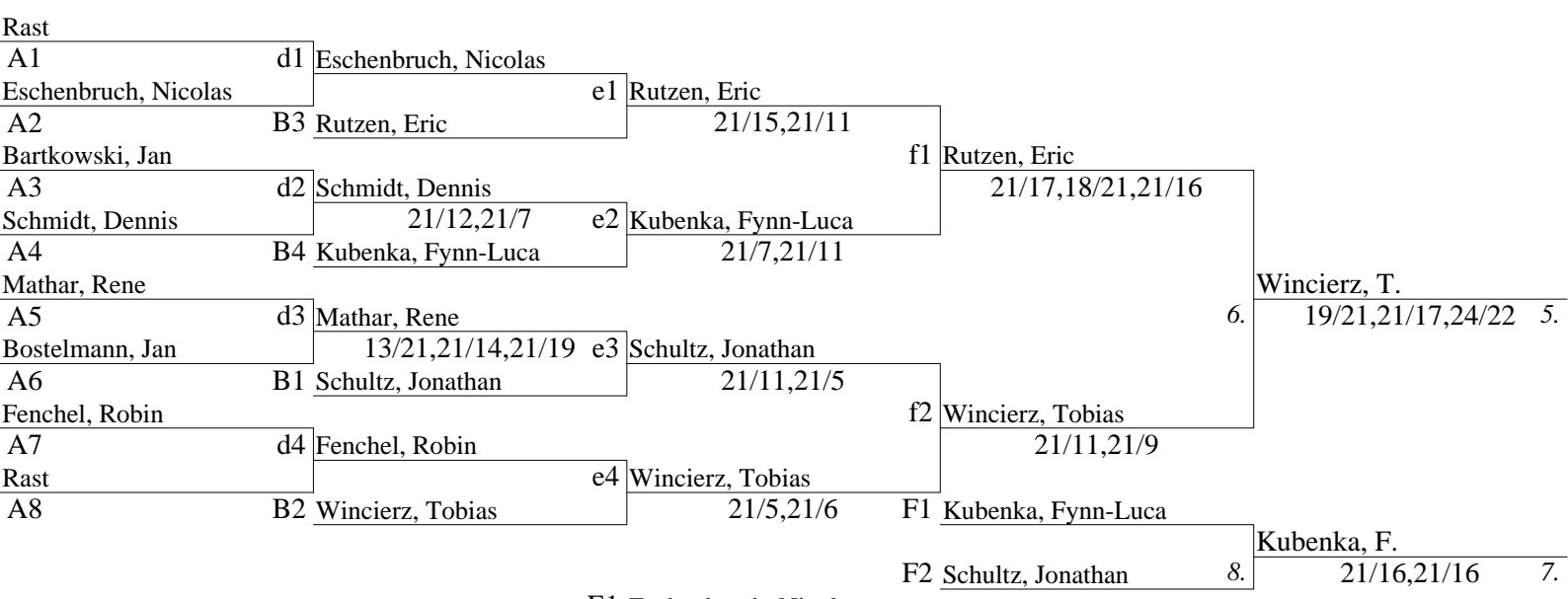
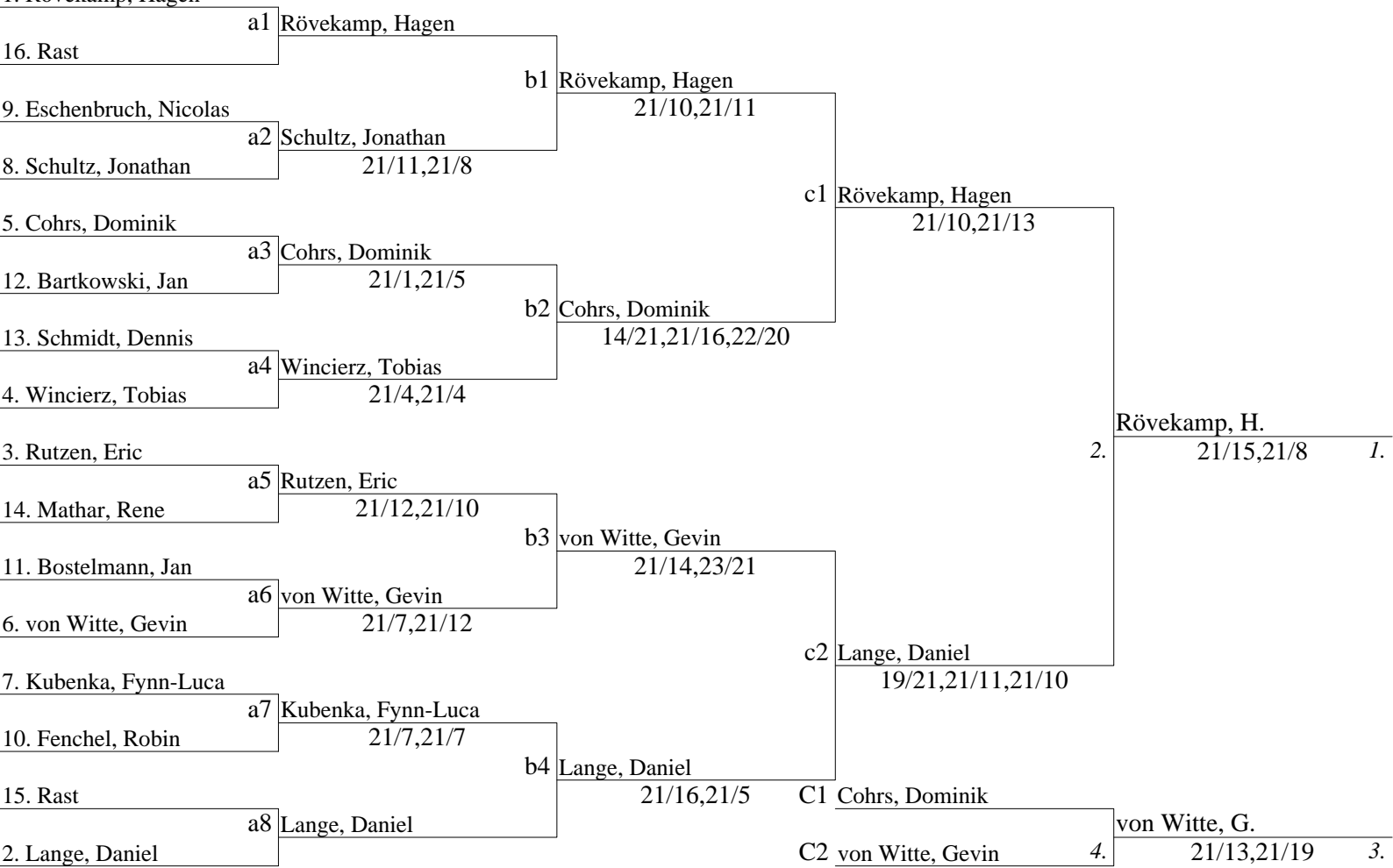

1. BBV/NBV-B-RLT Einzel U11-U22 2010_OT - HE U22

1. Juchim, Frank					
16. zu Putlitz, Moritz	a1	Juchim, Frank	21/3,21/2		
		b1 Juchim, Frank			
9. Kabadayi, Jannik			21/13,21/16		
8. Lehbrink, Tim	a2	Lehbrink, Tim	21/9,21/11		
		c1 Juchim, Frank			
5. Brandt, Fabian			21/11,22/24,21/13		
12. Rippe, Ruven	a3	Brandt, Fabian	21/11,21/15		
		b2 Brandt, Fabian			
13. Pyökäri, Onni			21/17,21/13		
4. Schulz, Mirco	a4	Schulz, Mirco	21/18,14/21,29/27		
					2. Juchim, F.
3. Wernicke, Calvin			22/20,21/15		
14. Hundt, Fabian	a5	Wernicke, Calvin	21/5,21/7		
		b3 Lehr, Tim			
11. Lehr, Tim			21/12,21/19		
6. Lisson, Lars	a6	Lehr, Tim	21/18,21/13		
		c2 Küspert, Flinx			
7. Küspert, Flinx			21/18,21/14		
10. Biendara, Gerrit	a7	Küspert, Flinx	21/10,21/18		
		b4 Küspert, Flinx			
15. Teise, Rudolf			17/21,21/19,21/12		
2. Malinowski, Patrick	a8	Malinowski, Patrick	C1 Brandt, Fabian		Brandt, F.
			C2 Lehr, Tim		4. 13/21,21/11,21/12
zu Putlitz, Moritz					
A1 Kabadayi, Jannik	d1	Kabadayi, Jannik	21/15,21/19		
A2 Rippe, Ruven	B3	Wernicke, Calvin	21/18,21/16		
		f1 Wernicke, Calvin			
A3 Pyökäri, Onni	d2	Rippe, Ruven	21/13,21/18		
A4 Hundt, Fabian	B4	Malinowski, Patrick	21/16,21/13		
		e2 Rippe, Ruven			
A5 Lisson, Lars	d3	Lisson, Lars	21/13,17/21,21/14		
A6 Biendara, Gerrit	B1	Lehbrink, Tim	21/5,21/2		
		e3 Lehbrink, Tim			6. Lehbrink, T.
A7 Teise, Rudolf	d4	Biendara, Gerrit	20/22,21/14,21/17		
A8	B2	Schulz, Mirco	21/10,21/10		
		f2 Lehbrink, Tim			
		F1 Rippe, Ruven			
		F2 Biendara, Gerrit			8. Rippe, R.
		E1 Kabadayi, Jannik			15/21,21/14,21/19
		E2 Malinowski, Patrick			7.
		E3 Lisson, Lars			10. Malinowski, P.
Lisson, L.			9/21,21/12,21/6		
11. 21/16,21/19					
		E4 Schulz, Mirco			9.
		D1 zu Putlitz, Moritz			
		D3 Hundt, Fabian			
		D2 Pyökäri, Onni			14. Teise, R.
Pyökäri, O.			21/19,21/3		
15. 21/7,21/15					
		D4 Teise, Rudolf			13.
		21/19,21/13			

1. BBV/NBV-B-RLT Einzel U11-U22 2010_OT - DE U22

1. Kaufmann, Jessica

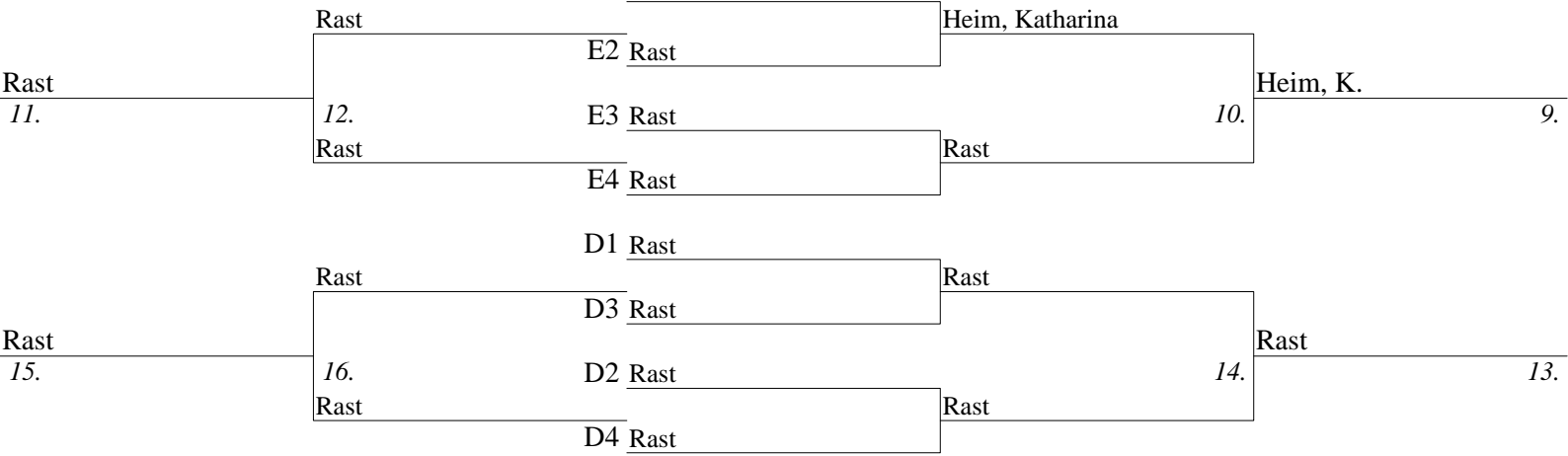
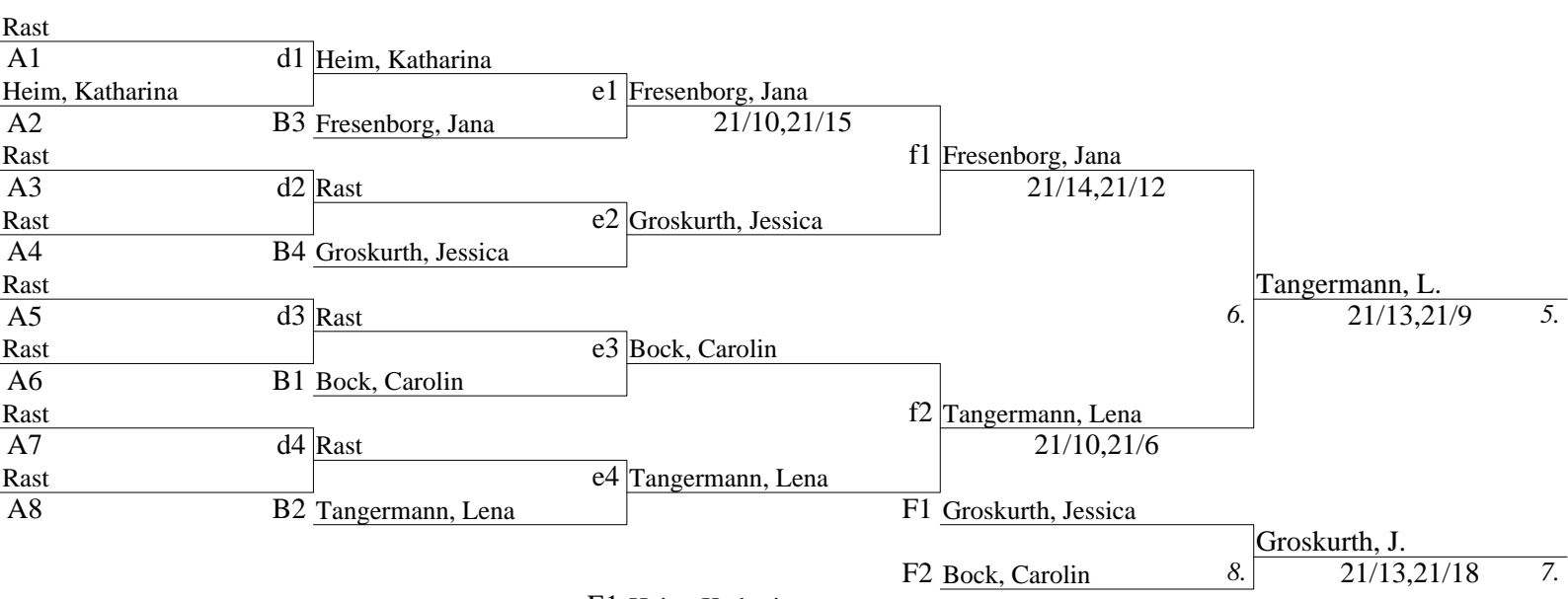
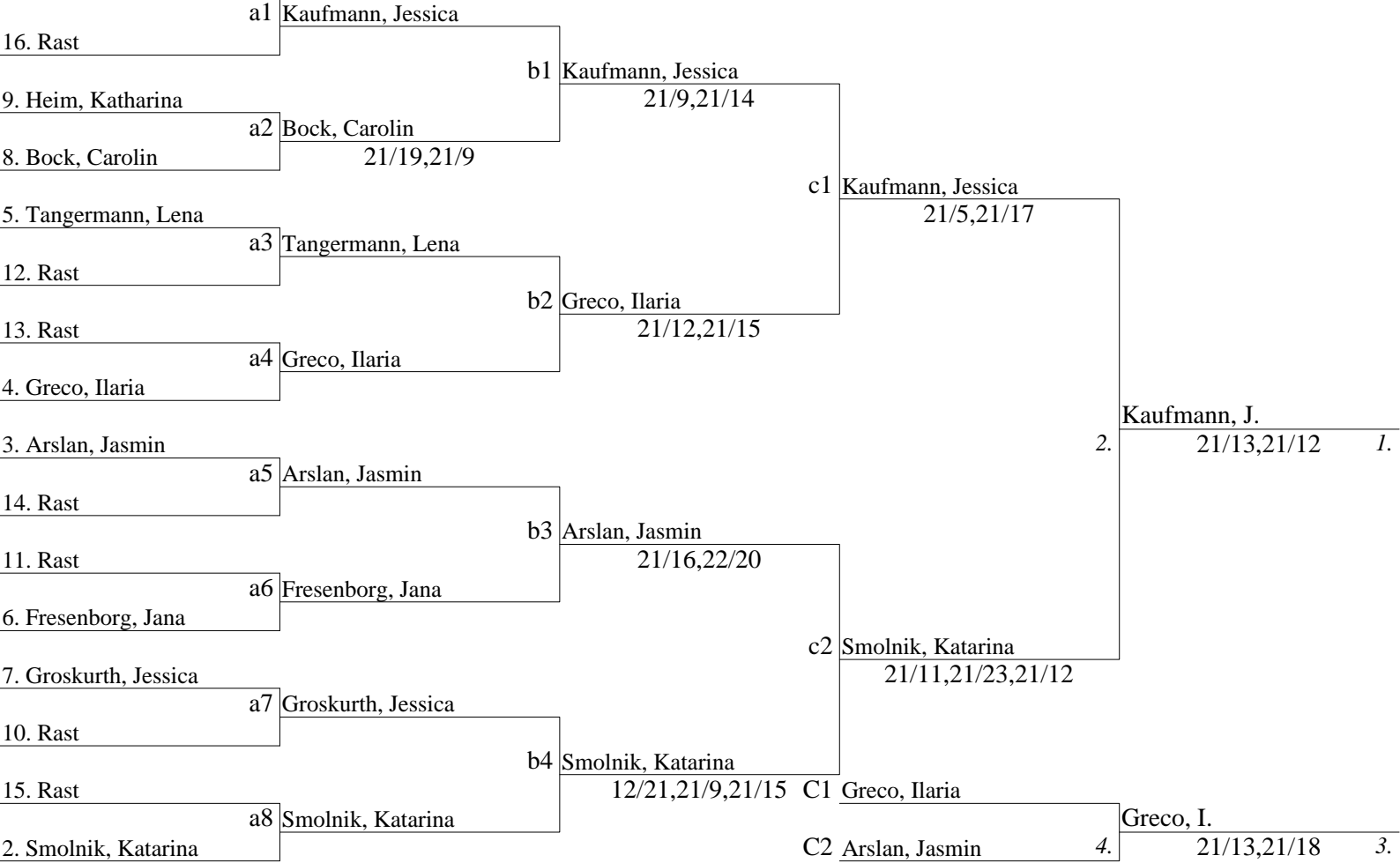

1. BBV/NBV-B-RLT Einzel U11-U22 2010_OT - ME U17

	Faires, K.	von der Wöste, C.	Rustler, J.	Hahn, A.	Gorecki, E.	Wrede, M.
Faires, K.		21/15,21/13	21/19,21/11	21/12,21/17	21/5,21/3	21/14,21/9
von der Wöste, C.	15/21,13/21		21/15,21/7	21/16,21/17	21/8,21/8	21/12,21/8
Rustler, J.	19/21,11/21	15/21,7/21		13/21,15/21	21/11,21/5	21/10,21/12
Hahn, A.	12/21,17/21	16/21,17/21	21/13,21/15		21/16,21/8	21/13,21/11
Gorecki, E.	5/21,3/21	8/21,8/21	11/21,5/21	16/21,8/21		5/21,5/21
Wrede, M.	14/21,9/21	12/21,8/21	10/21,12/21	13/21,11/21	21/5,21/5	
Punkte	210 : 118	196 : 133	164 : 164	188 : 160	74 : 210	131 : 178
Sätze	10 : 0	8 : 2	4 : 6	6 : 4	0 : 10	2 : 8
Spiele	5 : 0	4 : 1	2 : 3	3 : 2	0 : 5	1 : 4
Platz	1.	2.	4.	3.	6.	5.

1. Runde	1. Faires, Kimberly	6. Wrede, Melanie	21/14,21/9
	2. von der Wöste, Christine	5. Gorecki, Ewa	21/8,21/8
	3. Rustler, Julia	4. Hahn, Annika	13/21,15/21
2. Runde	Rustler, Julia	Wrede, Melanie	21/10,21/12
	Hahn, Annika	von der Wöste, Christine	16/21,17/21
	Gorecki, Ewa	Faires, Kimberly	5/21,3/21
3. Runde	Wrede, Melanie	Gorecki, Ewa	21/5,21/5
	Faires, Kimberly	Hahn, Annika	21/12,21/17
	von der Wöste, Christine	Rustler, Julia	21/15,21/7
4. Runde	von der Wöste, Christine	Wrede, Melanie	21/12,21/8
	Rustler, Julia	Faires, Kimberly	19/21,11/21
	Hahn, Annika	Gorecki, Ewa	21/16,21/8
5. Runde	Wrede, Melanie	Hahn, Annika	13/21,11/21
	Gorecki, Ewa	Rustler, Julia	11/21,5/21
	Faires, Kimberly	von der Wöste, Christine	21/15,21/13

1. BBV/NBV-B-RLT Einzel U11-U22 2010_OT - ME U15

1. Malz, Amelie

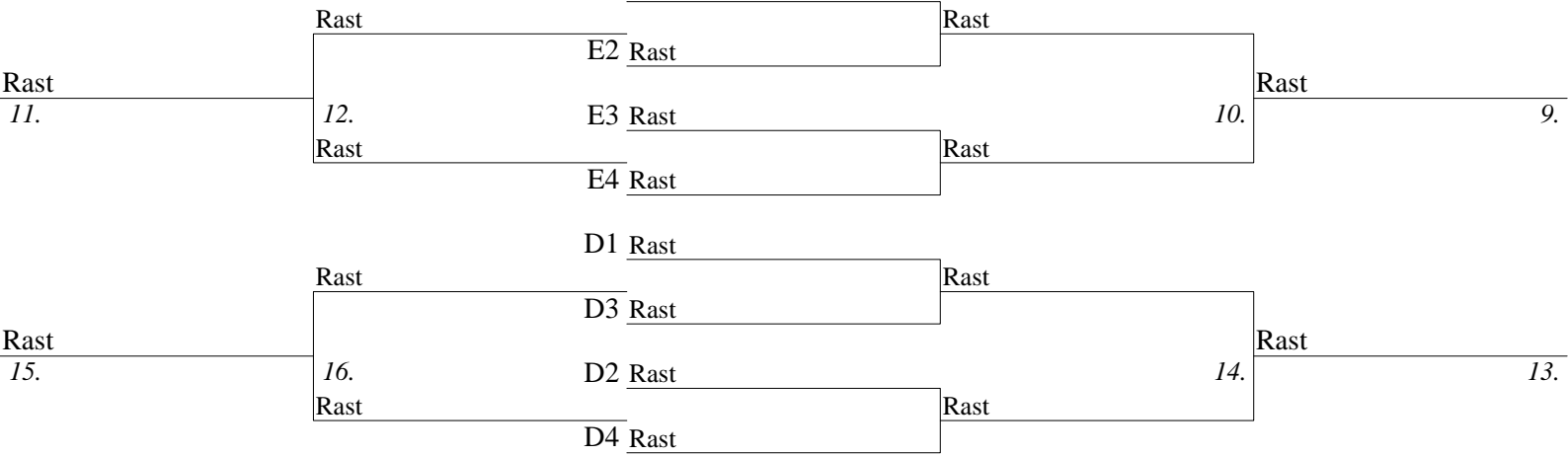
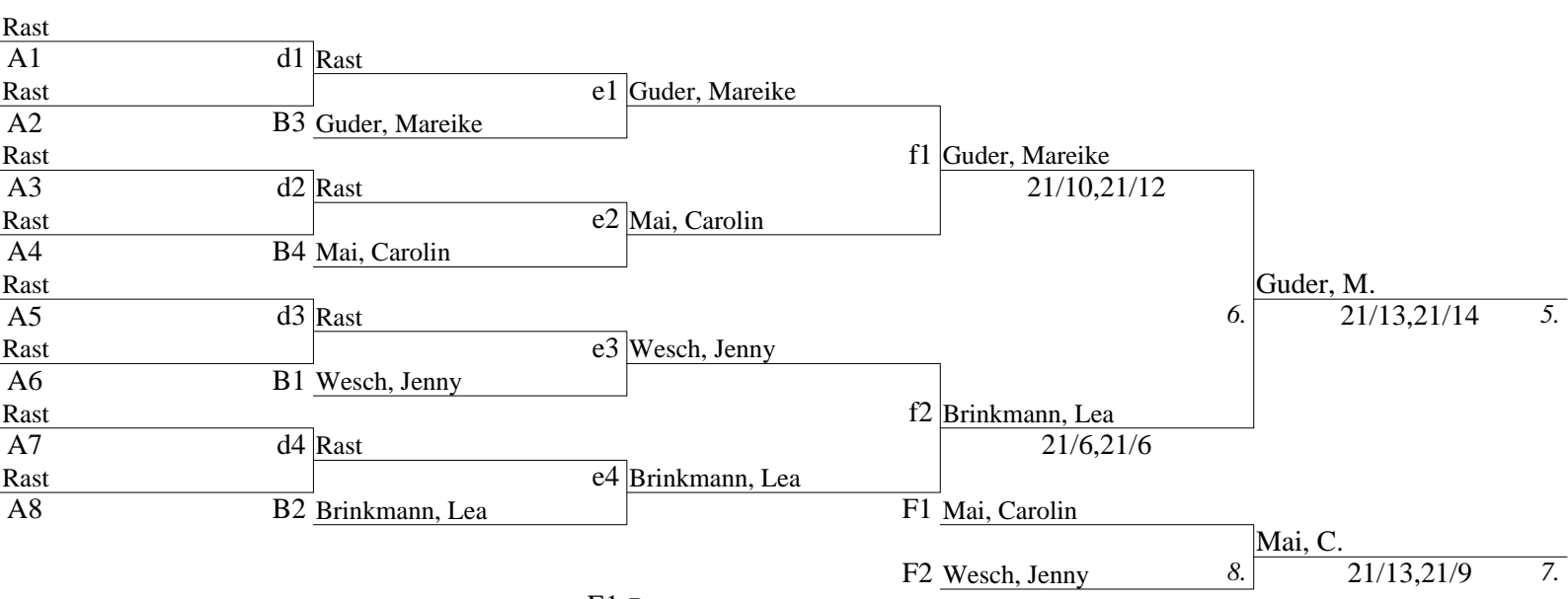
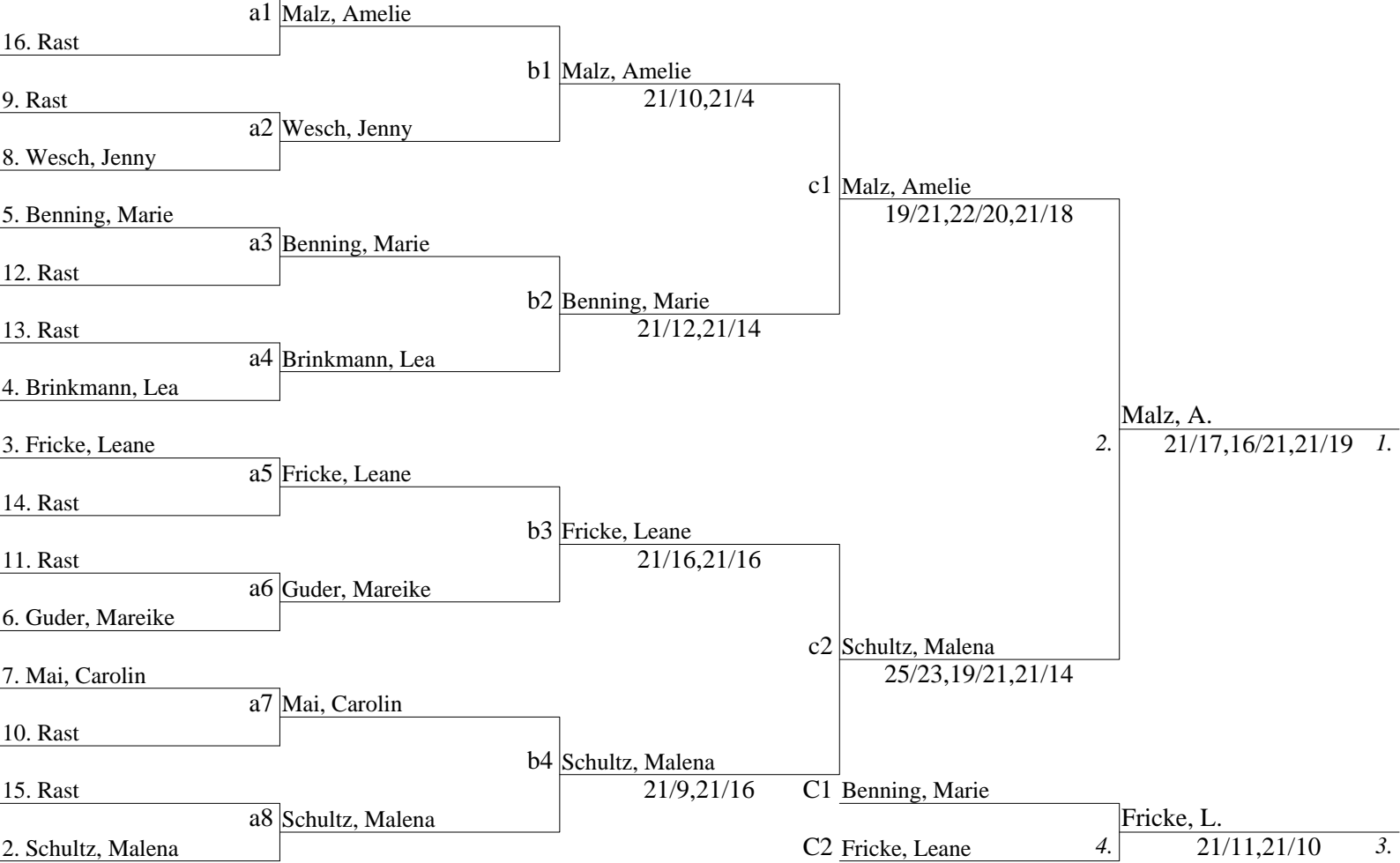

1. BBV/NBV-B-RLT Einzel U11-U22 2010_OT - JE U13



1. BBV/NBV-B-RLT Einzel U11-U22 2010_OT - ME U13

	Küspert, S.	Pollak, A.	Tanasic, D.	Thoden, J.	Felix, A.	Rast
Küspert, S.		21/14,21/14	20/22,21/19,21/17	21/11,21/10	21/16,19/21,21/12	
Pollak, A.	14/21,14/21		21/14,16/21,21/19	21/10,21/8	21/17,21/9	
Tanasic, D.	22/20,19/21,17/21	14/21,21/16,19/21		21/16,21/9	21/19,21/13	
Thoden, J.	11/21,10/21	10/21,8/21	16/21,9/21		20/22,18/21	
Felix, A.	16/21,21/19,12/21	17/21,9/21	19/21,13/21	22/20,21/18		
Rast						
Punkte	207 : 156	170 : 140	196 : 177	102 : 169	150 : 183	
Sätze	8 : 2	6 : 3	6 : 4	0 : 8	3 : 6	
Spiele	4 : 0	3 : 1	2 : 2	0 : 4	1 : 3	
Platz	1.	2.	3.	5.	4.	

1. Runde	1. Küspert, Stine	6. Rast	
	2. Pollak, Amelie	5. Felix, Alexandra	21/17,21/9
	3. Tanasic, Dilara	4. Thoden, Jule	21/16,21/9
2. Runde	Tanasic, Dilara	Rast	
	Thoden, Jule	Pollak, Amelie	10/21,8/21
	Felix, Alexandra	Küspert, Stine	16/21,21/19,12/21
3. Runde	Rast	Felix, Alexandra	
	Küspert, Stine	Thoden, Jule	21/11,21/10
	Pollak, Amelie	Tanasic, Dilara	21/14,16/21,21/19
4. Runde	Pollak, Amelie	Rast	
	Tanasic, Dilara	Küspert, Stine	22/20,19/21,17/21
	Thoden, Jule	Felix, Alexandra	20/22,18/21
5. Runde	Rast	Thoden, Jule	
	Felix, Alexandra	Tanasic, Dilara	19/21,13/21
	Küspert, Stine	Pollak, Amelie	21/14,21/14